

SLM

Spatial Light Modulators



Pioneers in Photonic Technology

PLUTO-2.1

Phase Only Spatial Light Modulator Series



The PLUTO Spatial Light Modulator is the all-rounder within our product range. It is the best qualified and diversified SLM platform with many versions optimized for specific requirements, including high reflectivity versions featuring a dielectric mirror for high power applications.

Furthermore, the PLUTO hardware is already implemented in different industrial applications.

Display Type	Reflective LCOS
Resolution	1920 x 1080 Pixel
Pixel Pitch	8.0 μm
Active Area / Diagonal	15.36 x 8.64 mm / 0.7"
Fill Factor	93%
Addressing Bit Depth	8 Bit
Input Frame Rate	60 Hz*
Signal Format	HDMI - HDTV Res.

*Please note that this is the input frame rate. The actual response time of the LC material depends on the version and configuration.

PLUTO-2.1 Series Versions

The PLUTO-2.1 series covers different versions optimized for different wavelength ranges between 350 nm and 2500 nm.

Besides standard versions we offer high retardation versions and high reflectivity versions for highly specialized requirements and applications.

Standard Versions

The standard PLUTO-2.1 devices include one version for the visible range, a flexible version for the near Infrared up to 1100 nm (which can also be used at the visible range), a version centered for the O-band and a version for the telecommunication waveband at 1550 nm.

All standard versions provide at least 2π phase retardation for the specified wavelength range.

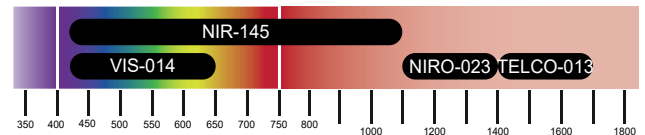

Device	λ Range	Maximum Phase	Average Refl.
VIS-014	420-650 nm	3.1π @ 633 nm	65%
NIR-145	420-1100 nm	2.2π @ 1064 nm	70-85%
NIRO-023	1100-1400 nm	4.2π @ 1300 nm	74%
TELCO-013	1400-1700 nm	3.9π @ 1550 nm	80%

High Retardation Versions

The high retardation versions (VIS and NIR) enable a modulo 4π or 6π encoding of optical functions depending on the wavelength.

These versions can also be used to minimize phase flicker effects by driving the high retardation display with low voltage settings for 2π phase retardation, however compromising the response time.

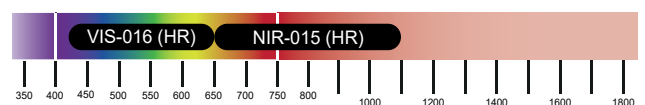

Device	λ Range	Maximum Phase	Average Refl.
VIS-016	420-650 nm	5.2π @ 633 nm	65%
NIR-015	650-1100 nm	3.6π @ 1064 nm	65-75%

High Reflectivity Versions

Some PLUTO-2.1 SLM display versions are equipped with a dielectric mirror coating to increase the reflectivity. Due to the increased reflectivity less absorption occurs and these versions can be used with higher incident laser power compared to the standard versions.

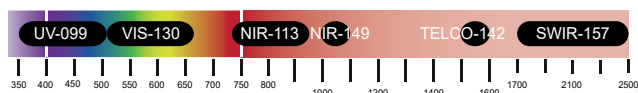

Device	λ Range	Maximum Phase	Average Refl.
UV-099	350-500 nm	4.9π @ 405 nm	90%
VIS-130	500-660 nm	2.5π @ 633 nm	94%
NIR-113	730-940 nm	2.5π @ 800nm	95%
NIR-149	1000-1100 nm	2.9π @ 1064 nm	93%
TELCO-142	1500-1600 nm	3.0π @ 1550 nm	90%
SWIR-157	1700-2500 nm	2.0π @ 2500 nm	90%

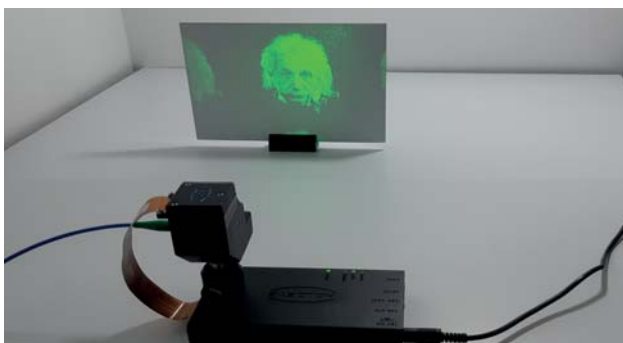

PLUTO-2.1 Flexible Driver

All PLUTO phase display versions can be driven with the same PLUTO-2.1 driver unit. This provides the flexibility to upgrade / adapt the SLM device to another version for different applications without the need to purchase a complete new SLM kit.

The PLUTO-2.1 driver uses an HDMI interface for addressing phase functions and an USB connection to communicate with the driver (to

change the voltage vs. gray level distribution (gamma control) and dynamic range (voltage across the LC cell) in order to calibrate the SLM for different wavelengths).

The driver has a trigger sync output to synchronize the device with external devices.

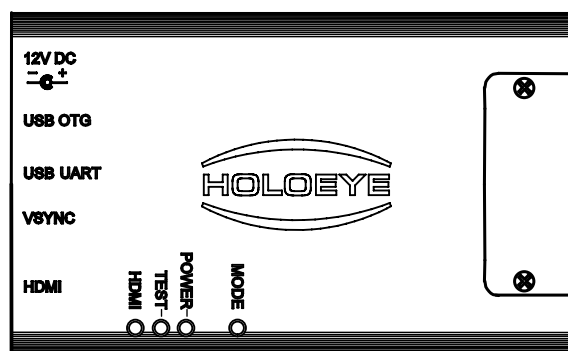

The PLUTO-2.1 driver features a dual-core ARM® Cortex™-A9 processor which includes on-chip memory. This enables the user to program additional functionality which is directly processed on the SLM device.

The dual-core system runs an embedded Linux™ SMP operating system and includes a library which provides full control and supervision of the display and driver board.



LETO-3

Phase Only Spatial Light Modulator Series



The LETO Spatial Light Modulator is our fast SLM platform with high band width. The SLM is capable of color sequential operation.

The LETO-3 phase modulator is based on reflective LCOS microdisplays with 1920 x 1080 pixel resolution. With a pixel pitch of only 6.4 μm and small interpixel gaps of 0.2 μm the LETO-3 SLM provides a high fill factor of 93%.

Display Type	Reflective LCOS
Resolution	1920 x 1080 Pixel
Pixel Pitch	6.4 μm
Active Area / Diagonal	12.29 x 6.91 mm / 0.55"
Fill Factor	93%
Addressing Bit Depth	8 Bit
Input Frame Rate*	60 Hz / (180 Hz - CFS)*
Signal Format	HDMI - HDTV Res.

*Please note that this is the input frame rate. The actual response time of the LC material depends on the version and configuration.

LETO-3 Series Versions

HOLOEYE offers three different LETO-3 Spatial Light Modulator versions which are optimized for the use at different wavelength ranges or for different applications.

- ➔ The LETO-3-VIS-009 version is optimized for 420 to 800 nm
- ➔ The LETO-3-NIR-081 version covers the wavelength range from 680 to 1100 nm
- ➔ The LETO-3-CFS-127 version is designed for color-field-sequential (CFS) operation.

All SLM versions provide at least 2π phase retardation for the specified wavelength range.

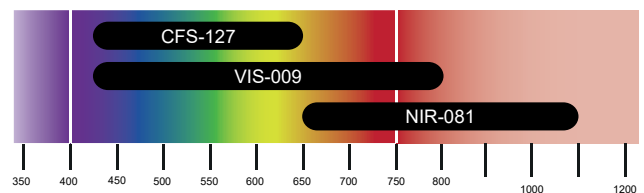

Version	λ Range	Maximum Phase	Average Refl.
CFS-127	420-650 nm	min 2π @ (CFS)	60-75 %
VIS-009	420-800 nm	2.8π @ 633nm	56-72 %
NIR-081	650-1100 nm	2.4π @ 1064nm	62-70 %

LETO-3 Color Sequential Mode

The LETO-3 SLM driver is prepared to work in Color-Field-Sequential (CFS) mode by addressing 3 x 8 bit within a frame (180 Hz).

The device features an LED-connector which can be used to synchronize the light source (color-switchable RGB lasers or LED lighting) with the device.

LETO-3-CFS-127 version is especially optimized for fast response times for the use in color-field-sequential mode.



LUNA

Phase Only Spatial Light Modulator Series



The LUNA Spatial Light Modulator is our most compact SLM platform for integration into small sized or even portable solutions.

The LUNA SLM is based on a small sized 0.39" LCOS microdisplay with a resolution of 1920 x 1080 pixels and 4.5 μm pixel pitch. The small pixel pitch of 4.5 μm enables high diffraction angles and a spatial resolution of 111 lp/mm.

Display Type	Reflective LCOS
Resolution	1920 x 1080 Pixel
Pixel Pitch	4.5 μm
Active Area / Diagonal	8.64 mm x 4.86 / 0.39"
Fill Factor	91%
Addressing Bit Depth	8 Bit
Input Frame Rate*	60 Hz / (180 Hz - CFS)*
Signal Format	DisplayPort - HD Res.

*Please note that this is the input frame rate. The actual response time of the LC material depends on the version and configuration.

LUNA Series Versions

HOLOEYE offers three versions of the LUNA Spatial Light Modulator optimized for different wavelength ranges.

- The LUNA-VIS-111 version is optimized for 420 to 650 nm and CFS mode
- The LUNA-NIR-147 version covers the wavelength range from 680 to 1100 nm
- The LUNA-TELCO-115 version is designed for typical telecommunication wavelengths in the area of 1400 - 1600 nm

The LUNA SLM is addressed at 60 Hz input frame rate using a state-of-the-art DisplayPort interface. The driver also features an USB connector for power supply and advanced configurations / calibrations.

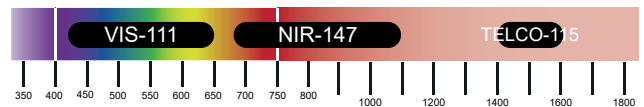

Version	λ Range	Maximum Phase	Average Refl.
VIS-111	420-650 nm	2.4 π @ 635nm	61-67 %
NIR-147	680-1100 nm	2.3 π @ 1064nm	60-75 %
TELCO-115	1400-1600 nm	2.3 π @ 1550nm	70 %

Small Design & Integrated ASIC

For the LUNA Spatial Light Modulator series the driver ASIC is embedded in the LCOS microdisplay itself. This saves board space which enables a very compact driver, makes integration more convenient and enables implementation into small sized and portable solutions. The standard driver box has a size of only 85 x 47 x 28.8 mm.

The microdisplay can even accept video data input via a 4-lane MIPI DSI. This novel approach brings phase only Spatial Light Modulator technology to a new level of potential for industrial implementations.



GAEA-2

Phase Only Spatial Light Modulator Series



The GAEA Spatial Light Modulator offers the highest resolution on the market with extremely small pixel pitch.

The GAEA-2 phase modulators are based on reflective LCOS microdisplays with 4160x2464 pixel resolution and 3.74 μm pixel pitch. The device also offers a faster mode at 3840x2160 pixel or 4000x2464 pixel resolution.

Display Type	Reflective LCOS
Resolution	max. 4160 x 2464 Pixel
Pixel Pitch	3.74 μm
Active Area / Diagonal	15.56 x 9.22 mm / 0.7"
Fill Factor	90%
Addressing Bit Depth	8 Bit
Input Frame Rate:*	
4160 x 2464 Pixel	60 Hz / (180 Hz - CFS)
3840 x 2160 Pixel	60 Hz / (180 Hz - CFS)
4160 x 2464 Pixel	58 Hz / (174 Hz - CFS)
Signal Format	HDMI

*Please note that this is the input frame rate. The actual response time of the LC material depends on the version and configuration.

High Spatial Resolution

The small pixel pitch of 3.74 μm enables high diffraction angles and results in a high effective spatial resolution at 133.5 lp/mm.

WL	Period	Angle	Period	Angle	Period	Angle
1550 nm	2 px	11.96°	4 px	5.95°	8 px	2.97°
633 nm	2 px	4.85°	4 px	2.43°	8 px	1.21°
532 nm	2 px	4.08°	4 px	2.04°	8 px	1.02°
450 nm	2 px	3.45°	4 px	1.72°	8 px	0.86°

GAEA-2 Series Versions

The GAEA-2 series covers 3 versions optimized for different wavelength ranges.

- ➔ The GAEA-2-VIS-036 version can be used between 420 and 650 nm
- ➔ The GAEA-2-NIR-069 version is optimized for 650 to 1100 nm
- ➔ The GAEA-2-TELCO-033 version is designed for typical telecommunication wavelengths in the area of 1400 - 1700 nm (e.g. C-Band)

The GAEA-2 SLM is a plug & play phase modulator device and can be addressed with phase functions via standard graphics cards. 8 bit gray level patterns (= 8 bit phase levels) can be addressed. The used graphics card must support HDMI-2 and be able to provide an uncompressed output of at least 3840 x 2160 pixel resolution.

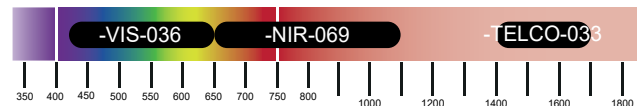

Version	λ Range	Maximum Phase	Average Refl.
VIS-036	420-650 nm	3π @ 633nm	62 %
NIR-069	650-1100 nm	2.4π @ 1064nm	60 %
TELCO-033	1400-1700 nm	2.6π @ 1550nm	72 %



ERIS-1.1

Analog Phase Only Spatial Light Modulator Series



The analog ERIS Spatial Light Modulator shows extreme phase stability, low latency and the display architecture allows low crosstalk LCOS-cell designs.

The ERIS-1.1 phase only Spatial Light Modulator is based on an 0.717" LCOS microdisplay with a resolution of 1920x1200 pixels and 8 μm pixel pitch. The SLM provides 8-bit phase levels but can also be operated in 10-bit phase mode.

Display Type	Reflective LCOS
Resolution	1920 x 1200 Pixel
Pixel Pitch	8.0 μm
Active Area / Diagonal	15.42 x 9.66 mm / 0.717"
Fill Factor	>92%
Addressing Bit Depth	8 Bit / 10 Bit
Input Frame Rate*	60 Hz / 120 Hz*
Signal Format	HDMI

*Please note that this is the input frame rate. The actual response time of the LC material depends on the version and configuration.

ERIS-1.1 Series Versions

The ERIS-1.1 series covers 3 versions optimized for different wavelength ranges.

- ➔ The ERIS -1.1-VIS-109 version can be used between 420 and 650 nm
- ➔ The ERIS-1.1-NIR-153 version covers a broad wavelength range from 420 to 1100 nm
- ➔ The ERIS-1.1-TELCO-110 version is designed for typical telecommunication wavelengths in the area of 1500 - 1600 nm (e.g. C-Band 1550 nm).

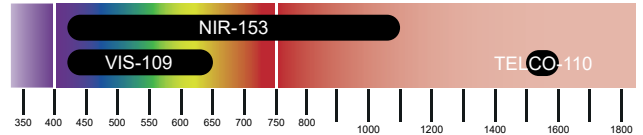

Version	λ Range	Maximum Phase	Average Refl.
VIS-109	420-650 nm	3.0 π @ 635nm	73%
NIR-153	420-1100 nm	2.1 π @ 1064nm	70-91 %
TELCO-110	1500-1600 nm	2.1 π @ 1550nm	89 %

ERIS-1.1 120 Hz Mode

The ERIS SLM offers a real 120 Hz operation mode. The refresh rates for both, input frames via the HDMI graphics interface and the output, are boosted to 120 Hz. The mode between standard 60 Hz and 120 Hz can simply be changed by configuring the HDMI graphics adapter to the desired frame rate or by selecting the mode at the HOLOEYE SLM Software.

ERIS-1.1 Flexible Driver

The driver features an embedded dual-core ARM® Cortex™-A9 processor running an embedded Linux operating system, which provides USB and network interfaces to address phase functions and do calibrations without the need for an HDMI interface.

In addition, the embedded system can be used to compute or store phase functions / images directly on the device.



LC 2012

Translucent Spatial Light Modulator

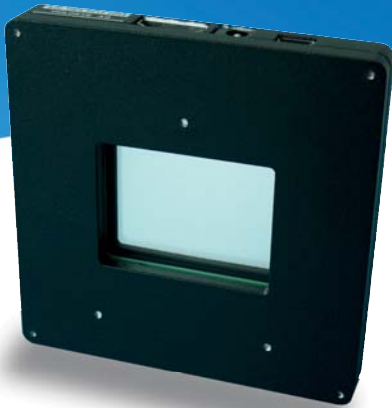

The LC 2012 is our most basic Spatial Light Modulator system based on a translucent liquid crystal microdisplay with a resolution of 1024 x 768 pixel (XGA). The device is mainly intended for proof of concepts and education.

The LC 2012 can be used for phase (phase mostly) and amplitude modulation applications in the visible range. The mode is defined by the configuration / incident polarization and polarizer-analyzer settings. The LC 2012 provides a phase shift of about 2π at 450 nm, about 1.8π at 532 nm and around 1π at 800 nm.

Display Type	Translucent LC
Resolution	1024 x 768 Pixel
Pixel Pitch	36 μm
Active Area / Diagonal	36.9 x 27.6 mm / 1.8"
Fill Factor	55 %
Addressing Bit Depth	8 Bit
Input Frame Rate	60 Hz
Signal Format	HDMI - XGA Res.

The microdisplay and drive electronics are packaged into a compact box for easy integration into optical setups. The device is addressed using a standard HDMI interface and brightness and contrast settings can be performed using an USB interface.

OptiXplorer Education Kit

The OptiXplorer is an educational kit for both introductory and advanced laboratory courses in optical physics. The kit is based on the LC 2012 Spatial Light Modulator.

Additionally a laser module, two rotatable polarizers and some optomechanical components are included in the kit.

OPTIXPLORER

The main topics covered in the six experimental modules listed below are polarization effects, amplitude modulation, phase modulation and Fourier Optics.

Topics & Experiments

- ▶ **AMP** – Using an SLM as amplitude modulator for image projection experiments
- ▶ **JON** – Measurement of the Jones matrix components of the TN-LC cells of the SLM and derivation of the cell parameters
- ▶ **LIN** – Using an SLM to create binary linear and 2D-separable beam-splitter gratings
- ▶ **RON** – Measurement of the phase modulation of the SLM using dynamically addressed Ronchi gratings
- ▶ **CGH** – Computer generated holograms with included lens and prism phase functions
- ▶ **INT** – Interferometric fringe-shift measurement of the phase modulation of the SLM

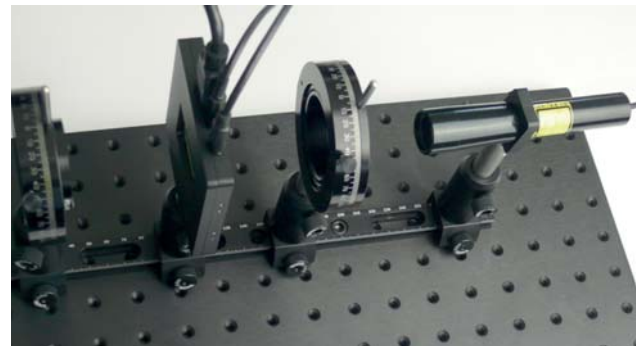

Together with a theoretical introduction in the handbook and the provided references to additional literature, the six experimental modules make the Optixplorer a powerful and low-cost educational tool that enables the demonstration and active exploration of a wide range of optical phenomena.

TMS

Thermal Management Systems



SLM Thermal Management Solutions

HOLOEYE SLMs are based on Liquid Crystal microdisplays. Physical properties of LC materials show a certain temperature dependence and a change in temperature may influence different optical SLM properties (phase shift, switching speed, phase stability...). SLM displays have their own power dissipation which varies between products and configurations.

To keep the performance / temperature stable an active thermal management system should be used.

Dependent on the device model and its power dissipation, the device version's reflectivity and the laser power used, HOLOEYE offers a thermal management system with passive heat sink or a system based on an active water cooling.



All HOLOEYE LCOS SLM displays feature an integrated temperature sensor. A USB connection is used to connect the temperature control unit to the PC.

The SLM Configuration Manager software can be used to read out the microdisplay temperature and keep it stable at a defined temperature.

TMS 001

The TMS 001 thermal management system is based on a Peltier element (thermoelectric cooler) in combination with a passive heat sink and can both cool and heat up the SLM display.



TMS 002

Even using HOLOEYE's high reflectivity SLM versions (with dielectric mirror) an active thermal management is required for high laser power applications. The TMS 002 thermal management system with active water cooling is especially designed for the use with higher laser power.



The up-to date display versions of all these SLM platforms use a standardized display packaging with a ceramic stiffener / back plate with excellent thermal conductivity. The displays can be mounted using the integrated magnets or by screws if required.

DPE

Diffraction Optical Engine



SLM Based Imaging

Typically SLMs are used in a broad range of technical applications at different wavelengths ranges from the UV to the mid IR.

At the visible range SLMs are also used for a growing number of imaging applications (e.g. holographic projection, 3D holographic displays or structured illumination). Especially in the field of AR / VR displays and Heads-up-Displays phase SLMs offer the advantage of superior light efficiency because the image is generated by diffraction (redistribution of light) instead of blocking light (amplitude modulation) like at conventional projection systems. Besides that the holographic approach can be used to add additional optical functions like dynamic focusing or aberration correction.

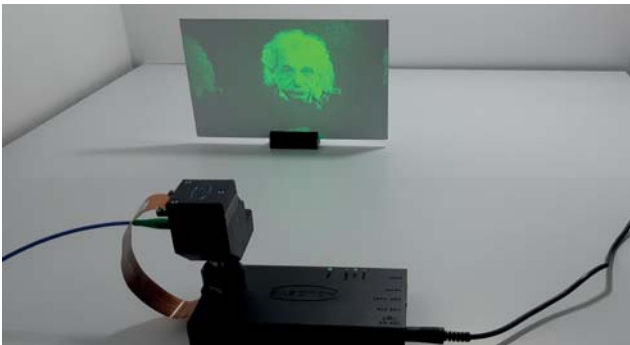

The diffractive approach using a phase SLM is fairly simple as it only requires a linearly polarized light source and the SLM itself. However, as diffraction angles are limited (dependent on pixel size of the used SLM) it might be necessary to use additional optics to magnify the output image.

As the development of such a diffraction based projection system is complex and time consuming, HOLOEYE offers a compact standard Diffraction Projection Engine which works for a broad field of imaging applications.

Diffraction Projection Engine

The HOLOEYE Diffraction Projection Engine is compatible with the current versions of PLUTO-2, LETO, GAEA-2, ERIS and the LUNA Spatial Light Modulators.

The compact projection engine is designed to work with a linearly polarized laser source coupled into a polarization-maintaining single mode fiber with FC/APC connector. It can also be used with fiber coupled RGB laser sources for color sequential hologram projection using a fast SLM like the LETO device.

The angular magnification is in the area of 5.3x (slightly dependent on wavelengths and pixel pitch). The working distance ranges from 15 cm (for GAEA SLM) / 27 cm (for PLUTO SLM) to infinity.

- ▶ FoV GAEA: 42°(full angle): ~240 mm @ 300 mm distance
- ▶ FoV LUNA: 34°(full angle): ~185 mm @ 300 mm distance
- ▶ FoV LETO: 24°(full angle): ~130 mm @ 300 mm distance
- ▶ FoV PLUTO: 20°(full angle): ~110 mm @ 300 mm distance
- ▶ FoV ERIS: 20°(full angle): ~110 mm @ 300 mm distance

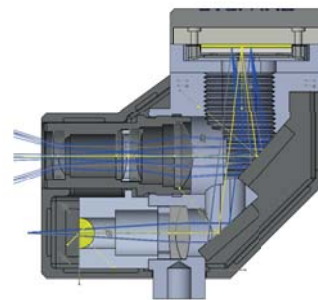

Specifications

Wavelengths Range	450 - 650 nm
Transmission Optics	75 % (@520 nm)
Fiber Connector	FC/APC
SLM Illumination Angle	< 7.5 degrees
Angular Magnification	~5.3 x
Mechanical Dimension	50 x 40 x 30 (mm)
Working Distance	15 to 27 cm – infinity
FoV	DEP on SLM/Wavelength

SLM Software

Software for HOLOEYE Spatial Light Modulators

All HOLOEYE Spatial Light Modulators are addressed like a monitor via standard HDMI or DisplayPort. Meaning the SLM actually acts like a standard monitor device and no special software or drivers are necessary to operate the SLM (standard image viewer software can be used).

For an easy start and even more convenient operation HOLOEYE provides a Pattern Generator software (for calculation of different optical functions), a Slideshow Player software (for easy addressing of precalculated functions

or images on the SLM) and an SDK for different programming environments.

The SLM Display SDK also supports the use of multiple SLMs simultaneously and offers a canvas mode to address different functions/content on tiled SLM display area.

Of course also a convenient Configuration Manager software for configuration, calibration and temperature management is delivered with each Spatial Light Modulator device.

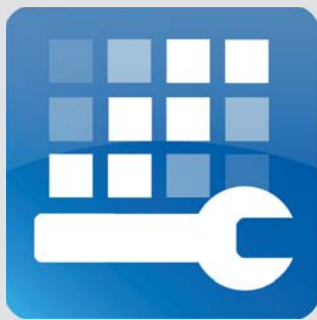

SLM DISPLAY SDK

SDK for LabView, Matlab, Python Octave and GCC environments



SLM CONFIGURATION MANAGER

Software for device configuration and calibration



SLM PATTERN GENERATOR

Generation of different optical functions



SLM SLIDESHOW PLAYER

Image slideshow software for HOLOEYE SLMs

HOLOEYE Photonics AG

Volmerstr. 1
12489 Berlin, Germany

Phone: +49 (0)30 4036 938 0

Fax: +49 (0)30 4036 938 99

slm@holoeye.com

www.holoeye.com



Pioneers in Photonic Technology